

DATI DIMENSIONALI

Placche e supporti Axolute AIR

PLACCHE AXOLUTE AIR

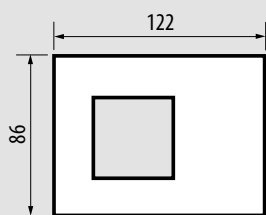

HW4819...

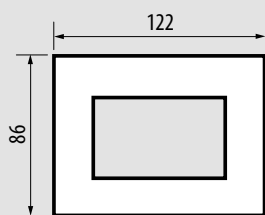

HW4803...

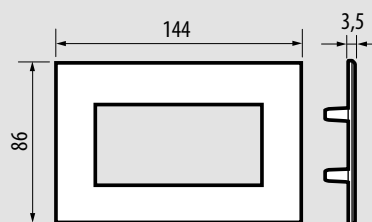

HW4804...

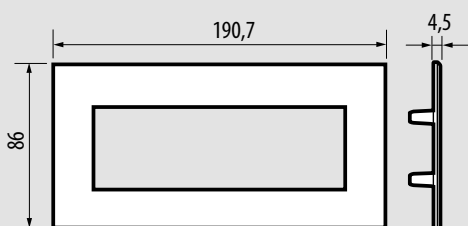

HW4806...

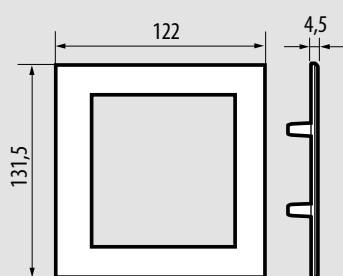

HW4826...

SUPPORTI AXOLUTE AIR

2 E 3 MODULI

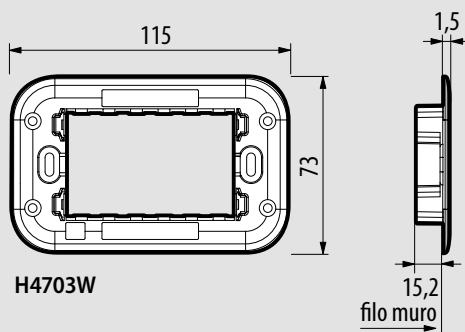

H4703W

4 MODULI

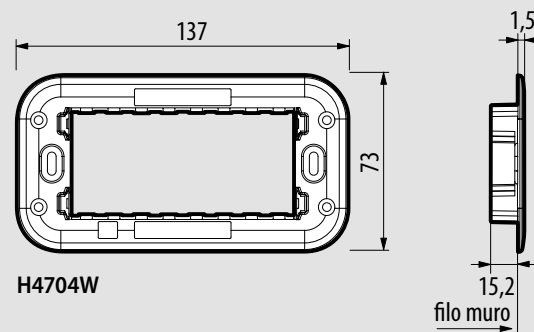

H4704W

6 MODULI

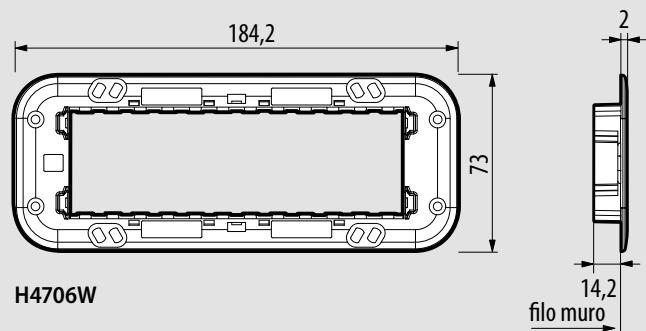

H4706W

3+3 MODULI

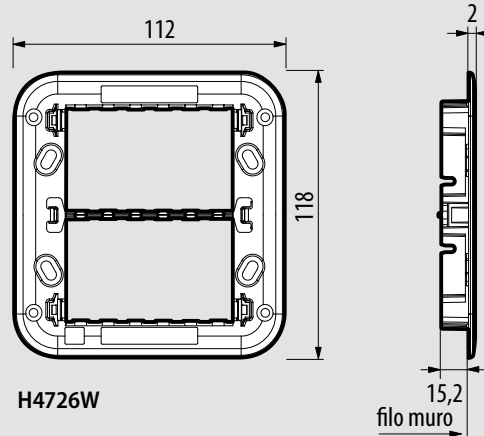

H4726W

DATI DIMENSIONALI

Placche Axolute rettangolari ed ellittiche

PLACCHE AXOLUTE RETTANGOLARI

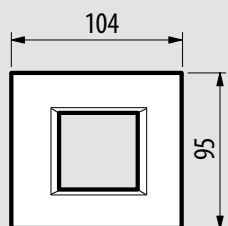

HA4802...

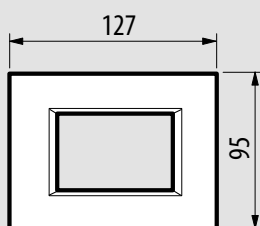

HA4803... - HC4657M3
- HS4657M3

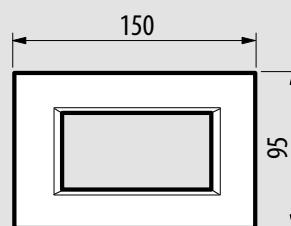

HA4804... - HC4657M4
- HS4657M4

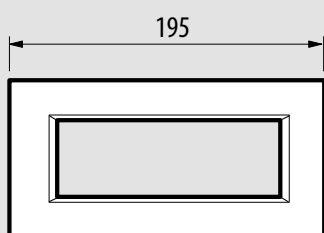

HA4806...

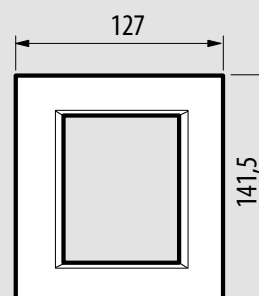
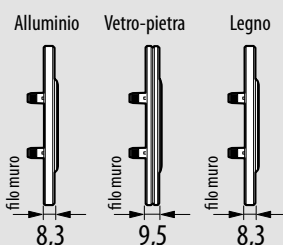

HA4826...

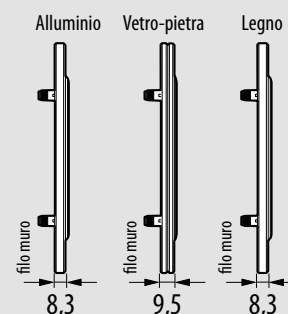

PLACCHE AXOLUTE ELLITTICHE

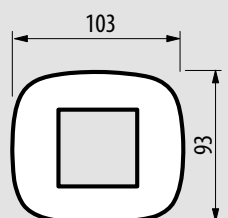

HB4802...

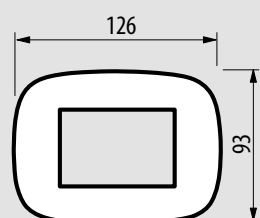

HB4803...

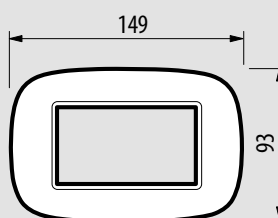

HB4804...

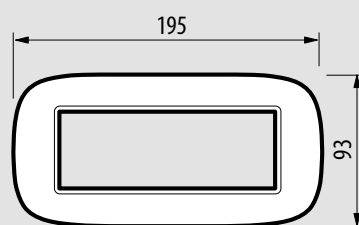

HB4806...

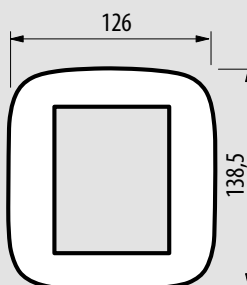
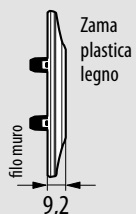

HB4826...

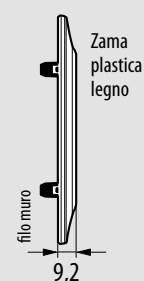

DATI DIMENSIONALI

Supporti Axolute

2 MODULI

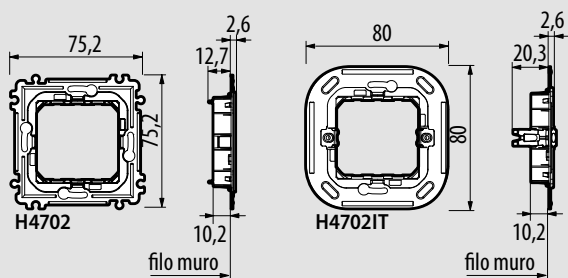

3 MODULI

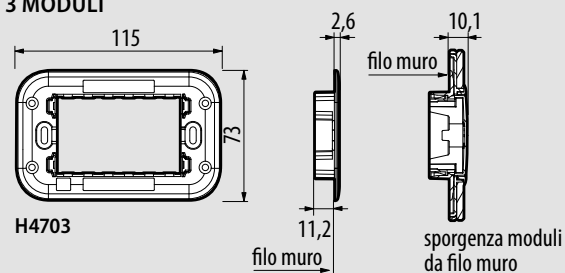

4 MODULI

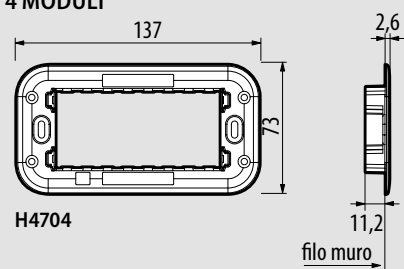

6 MODULI

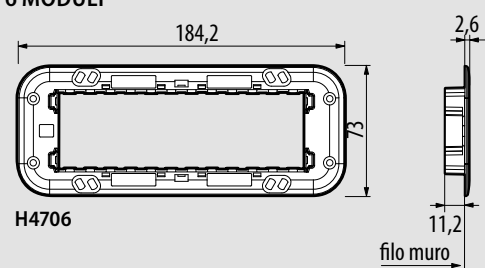

3+3 MODULI

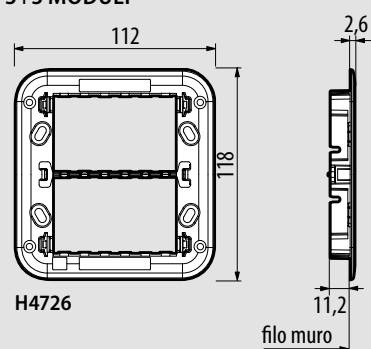

DATI DIMENSIONALI

Scatole, apparecchi modulari

APPARECCHI MODULARI

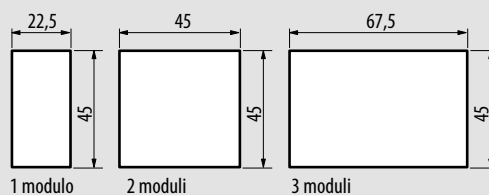

SCATOLE DA PARETE

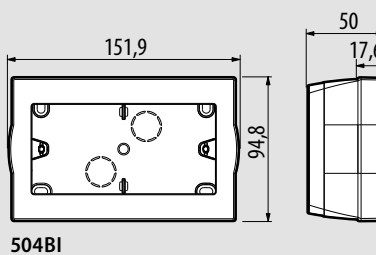
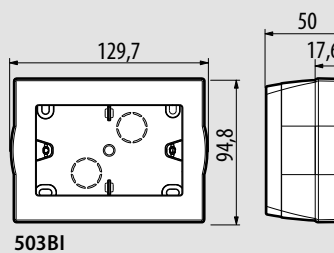
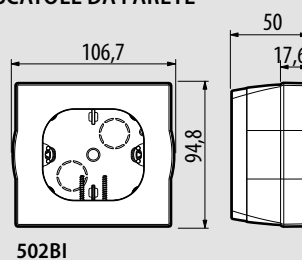

SMARTHER2

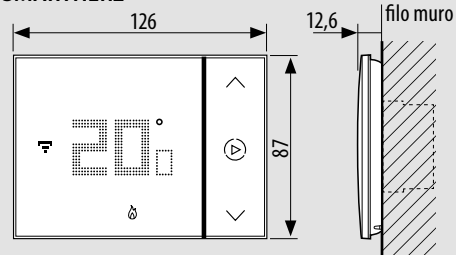

XW8002 - XM8002 - XG8002

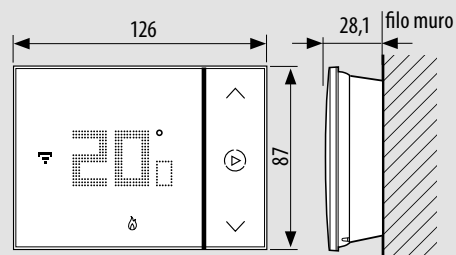

XW8002W